

SmallRig

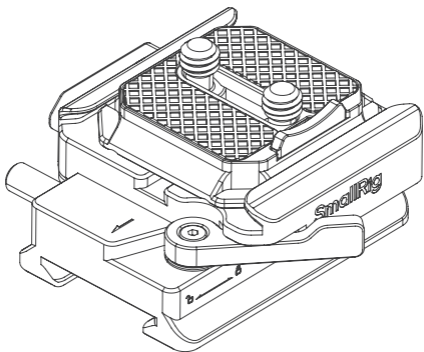

HawkLock H38 Arca-Swiss Quick Release Plate for DJI Stabilizers

DJI 稳定器迅鹰H38阿卡快装板

Operating Instruction / 操作指引

Foreword / 前言

- Thank you for purchasing SmallRig's product.
感谢您购买 SmallRig 产品。
- Please read this Operating Instruction carefully.
使用本产品之前，请仔细阅读操作指引。
- Please follow the safety warnings.
请注意所有警告提示并遵循使用操作指引的所有指令。

In the Box / 包装清单

Arca-Swiss Quick Release Plate 阿卡快拆板	× 1
Arca-Swiss Quick Release Baseplate 阿卡快拆底座	× 1
Allen Wrench 六角扳手	× 1
Guarantee Card 保修卡	× 1

Specifications / 产品参数

Product Dimensions 产品尺寸	2.12 × 2.09 × 1.22in 54.0 × 53.2 × 31.0mm
Product Weight 产品重量	3.7 ± 0.17oz 104.0 ± 5.0g
Material(s) 主要材质	Aluminum Alloy, Stainless Steel 铝合金、不锈钢
Compatibility 适配性	DJI RS 2 / RSC 2 / RS 3 / RS 3 Pro / RS 3 mini / RS 4 / RS 4 Pro 大疆 RS 2 / RSC 2 / RS 3 / RS 3 Pro / RS 3 mini / RS 4 / RS 4 Pro

Product Details / 产品介绍

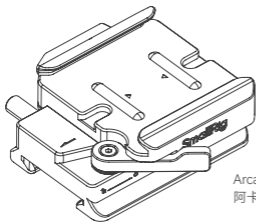

Arca-Swiss Quick Release Baseplate
阿卡快拆底座

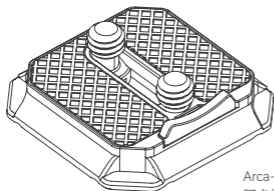

Arca-Swiss Quick Release Plate
阿卡快拆板

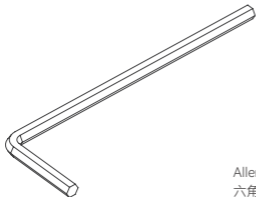

Allen Wrench
六角扳手

Installation Instruction / 安装步骤

(1)

1

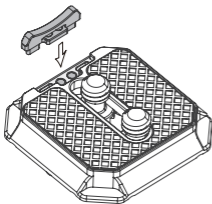

2

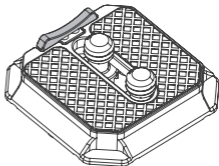

(2)

1

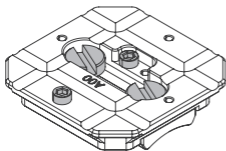

2

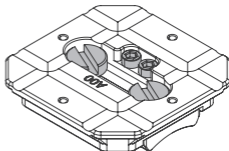

(3)

1

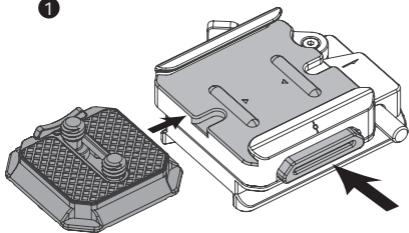

2

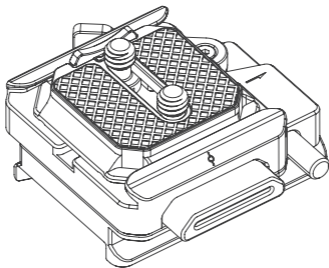

Manufacturer: Shenzhen Leqi Innovation Co., Ltd.

Add: Rooms 103, 501 and 601, Building 5, Fenghe Industrial Park, Nos. 1301-50
Guanguang Road, Longhua District, Shenzhen, Guangdong, China.

制造商: 深圳市乐其创新股份有限公司

地址: 中国广东省深圳市龙华区观澜街道新澜社区观光路 1301-50 号丰和工业园
厂房 5 栋 103、501、601

Consignor: Shenzhen LC Co., Ltd.

Add: Rooms 602, Building 5, Fenghe Industrial Park, No. 1301-50 Guanguang Road,
Xinlan Community, Guanlan Street, Longhua District, Shenzhen, Guangdong, China.

委托商: 深圳市乐长科技有限公司

地址: 中国广东省深圳市龙华区观澜街道新澜社区观光路 1301-50 号丰和工业园
厂房 5 栋 602

执行标准: GB/T 26572-2011

RoHS



合格证
已检验



Séparez les éléments avant de trier



中国制造

Made in China