

SmallRig

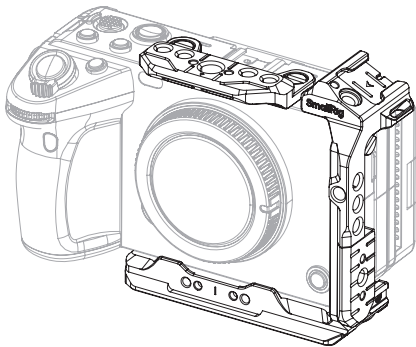

HawkLock Quick Release Half Cage for Sony FX3 / FX30

索尼FX3 / FX30迅鹰快拆半包拓展框

Operating Instruction / 操作指引

Foreword / 前言:

- Thank you for purchasing SmallRig's product.
感谢您购买 SmallRig 产品。
- Please read this Operating Instruction carefully.
使用本产品之前, 请仔细阅读操作指引。
- Please follow the safety warnings.
请注意所有警告提示并遵循使用操作指引的所有指令。

In the Box / 包装清单

L-shaped Cage	× 1	L型拓展框	× 1
Top Plate (NATO Rail)	× 1	顶板	× 1
1/4"-20 Screw	× 1	1/4"-20螺丝 (固定侧边用)	× 1
Operating Instruction	× 1	操作指引	× 1
Guarantee Card	× 1	保修卡	× 1

Product Details / 产品介绍

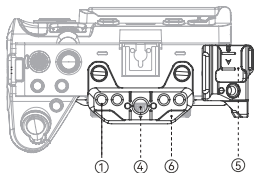

① 1/4"-20 Threaded Hole
1/4"-20 螺纹孔

② 1/4"-20 Locating Hole
1/4"-20 定位孔

③ 3/8"-16 Threaded Hole
3/8"-16 螺纹孔

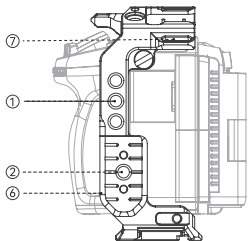

④ ARRI 3/8"-16 Locating Hole
阿莱 (ARRI) 定位孔

⑤ Cold Shoe Mount
冷靴

⑥ NATO Rail
滑条

⑦ Strap Slot
肩带 / 腕带接口

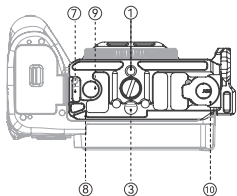

⑧ Arca-Swiss Quick Release Plate
阿卡规格快装板

⑨ QD Socket
QD 接口

⑩ Flat-Head Wrench
一字扳手

Cage Installation Instruction / 拓展框安装步骤

1

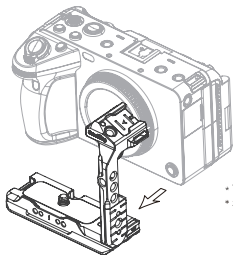

- The package does not include the camera.
- 相机机身需另购

2

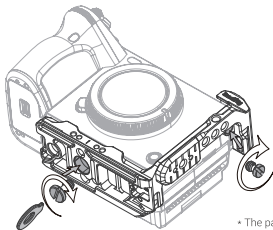

- The package does not include the camera.
- 相机机身需另购

3

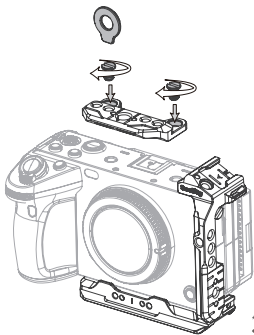

- * The package does not include the camera.
- * 相机机身需另购

Specifications / 产品参数

Product Dimensions 产品尺寸	4.0 × 3.0 × 1.8in 102.6 × 75.6 × 44.8mm
Product Weight 产品重量	3.6 ± 0.2oz 102.0 ± 5.0g
Material (s) 主要材质	Aluminum Alloy, Stainless Steel, Silicone 铝合金、不锈钢、硅胶

* 技术参数如有改动，以实物为准，恕不另行通知。

Specifications subject to change without prior notice. Please refer to the physical product for the most up-to-date information.

Manufacturer: Shenzhen Leqi Innovation Co., Ltd.

制造商: 深圳市乐其创新股份有限公司

Add: Rooms 103, 501 and 601, Building 5, Fenghe Industrial Park,
Nos. 1301-50 Guanguang Road, Longhua District, Shenzhen,
Guangdong, China.

地址: 中国广东省深圳市龙华区观澜街道新澜社区观光路1301-50号
丰和工业园厂房5栋103、501、601

Consignor: Shenzhen LC Co., Ltd.

委托商: 深圳市乐长科技有限公司

Add: Rooms 602, Building 5, Fenghe Industrial Park,
No. 1301-50 Guanguang Road, Xinlan Community,
Guanlan Street, Longhua District, Shenzhen, Guangdong, China.

地址: 中国广东省深圳市龙华区观澜街道新澜社区观光路1301-50号
丰和工业园厂房5栋602

CE RoHS



执行标准: GB/T 26572-2011
LQ-P1334-18

Made in China
中国制造