

# SmallRig

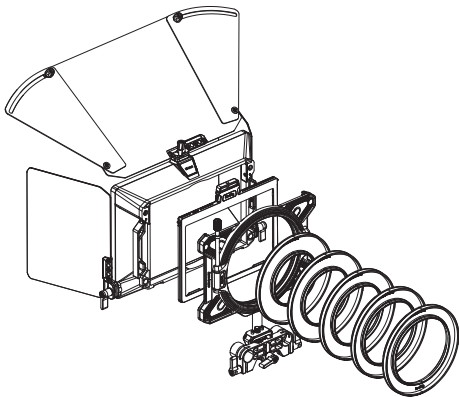

Star-Trail / Revo-Arcane Matte Box Systems  
Instructions and Accessories Introduction

Thank you for purchasing SmallRig's product.

## Warnings

- Please read this User Manual carefully.
- Please keep the user manual properly, and be sure to attach this user manual when handing over the product to others.
- Please heed all warnings and follow all instructions in the owner's manual.
- Incompatible with 2mm thick 100 x 100mm and 100 x 150mm slide-in filters.
- Cannot hold the slide-in filter and circular filter at the same time.
- Incompatible with circular filters having an outside diameter larger than 100mm.
- Please put Filter Frame (4 x 4") 3648 in the innermost slot near the lens.
- Please put the VND Filter Kit 3651 in the innermost slot near the lens after removing the lens hood.



**Only compatible with 4mm slide-in filters.**

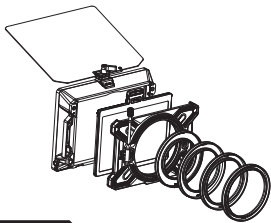

**ID: 3556**

Multifunctional Modular Matte Box (Φ95mm)  
Basic Kit

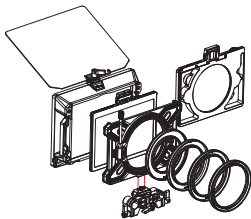

**ID: 3645**

Multifunctional Modular Matte Box (Φ95mm)  
VND Kit

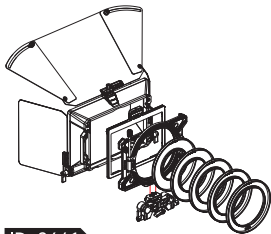

**ID: 3641**

Multifunctional Modular Matte Box (Φ114mm)  
Basic Kit

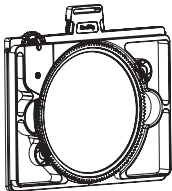

**ID: 3651**

VND Filter Kit

## Optional Kits for Star-Trail Series



ID: 3647

Side Flag Kit  
( $\Phi$ 95mm)



ID: 3383

Adapter Rings Kit  
for mini Matte Box



ID: 3654

Clamp-On Ring Kit  
( $\Phi$ 80 / 85 ~ 95mm)

---

## Optional Kits for the Revo-Arcane Series



ID: 3408

Clamp-On Ring Kit  
for Matte Box 2660



ID: 3409

Silicone Donut with 114mm Rear Opening  
for Matte Box 2660

---

## Optional Kits for Star-Trail and Revo-Arcane Series

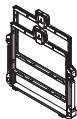

ID: 3649

Filter Frame Kit (4 x 5.65")



ID: 3648

Filter Frame (4 x 4")

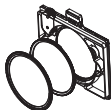

ID: 3651

VND Filter Kit

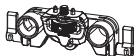

ID: 3652

15mm LWS Support

## Installation of the Matte Box

- 1 Select the appropriate threaded adapter ring based on the lens being used.



Note: A lens with a 95mm outer diameter can be mounted directly without an adapter ring.

- 2 Align the matte box with the lens centerline.

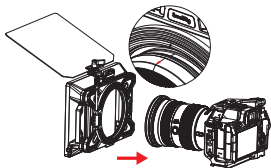

- 3 Secure the Matte Box by twisting the screw

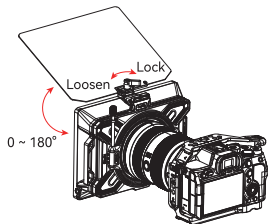
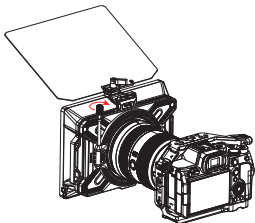

## Mounting filters into the 4 × 5.65" and 4 × 4" Filter Frames

- 1 Press the filter frame safety lock to remove the filter frame

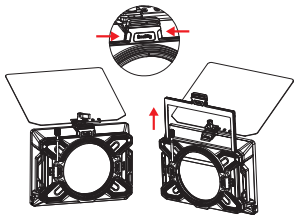

- 2 The filter is inserted diagonally into the filter frame

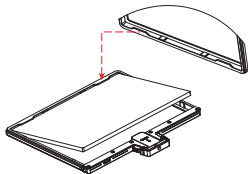

- 3 Pull up the automatic lock to allow the filter to lay flat and release the lock to complete the installation

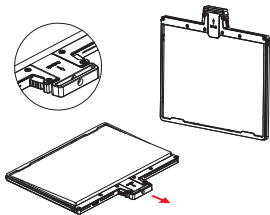

- 4 Align the frame in the guide slot and push down until you hear a "click". Installation is complete!

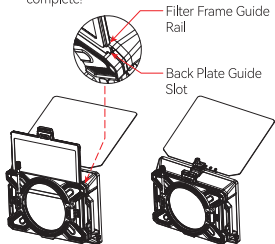

## Removal and Installation of the Matte Cover

- 1** Pull up the locks on both sides of the matte cover at the same time

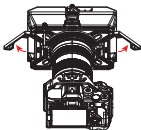

- 2** Unlock by pulling the top section in the direction shown

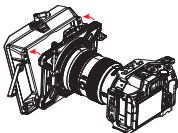

- 3** Completely remove the matte cover by pulling up as indicated

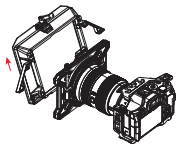

- 4** Align the connection points

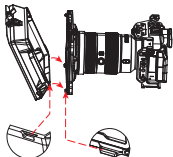

Matte Box  
slot

Back Plate  
inverted tab

- 5** Push the matte cover towards the Back Plate

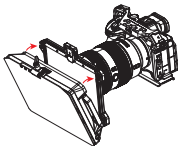

- 6** When you hear a "Click," installation is completed

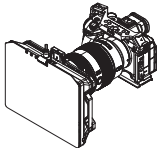

## Adding Additional Filters

4 × 5.65" Filter Frame Kit  
ID: 3649

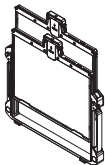

- 1 Align the connection points

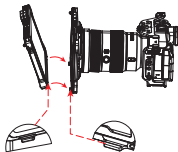

U-shaped  
filter frame  
slot

Backplate  
inverted tab

- 2 Push the filter frame kit  
towards the Back Plate

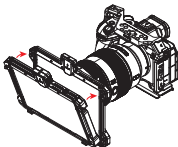

- 3 When you hear a "Click," installation is  
completed

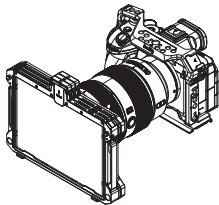

- 4 Complete the installation of the matte cover

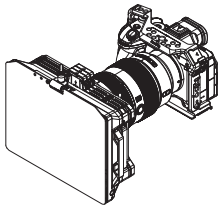



## Removal and Installation of the VND Filter

VND Filter Kit

ID: 3651

Consists of two CPL filters

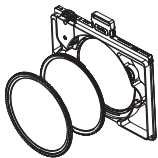

- 1** Align the white wire and separately magnetically aligned for installation



White positioning line



Round filter limit slot

- 2** Locking double-sided anti-release stoppers

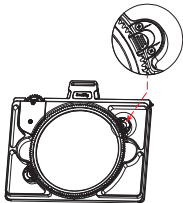

- 3** Align the frame in the guide slot and push down until you hear a "click". Installation is complete!

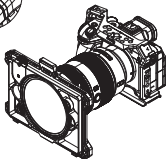

- 4** Manual adjustment of the VND Stops

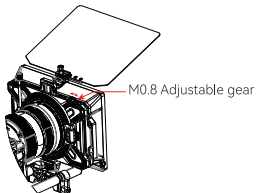

Caution:

- 1: To install the VND filter kit remove the matte cover
- 2: Close to the lens for installation

## Installation steps for 15mm LWS Support

15mm LWS Support

ID: 3652

Loosen the knob to ensure free adjustment  
up and down

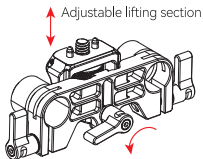

- 1 Align the screw threads of matte box,  
Locking and fastening

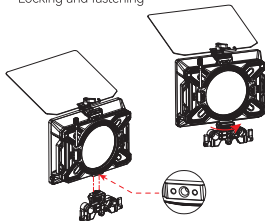

- 2 Align and push in the standard 15mm rod  
and adjust the position

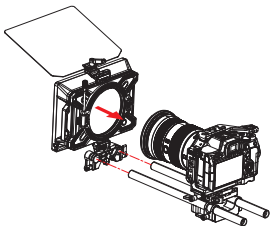

- 3 Adjusting the height of the lens  
Adjusting knobs, Locking and fastening

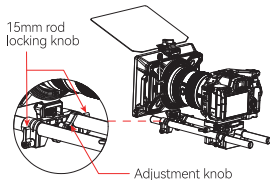

Note: Compatible with standard 15mm rod  
system, height Adjustable to 20.4mm

## Replacement of the top flag and installation of the side flags

Side Flag Kit (95mm)

ID: 3647

Only suitable for Star-Trail series matte boxes



1 Removal of top flag

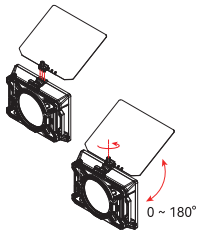

2 installation of top flag

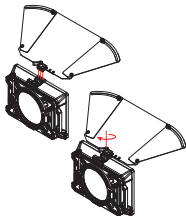

3 Adjust the top flag sector angle

adjustable nuts for  
Scalloped flag

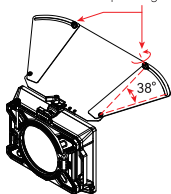

4 installation of side flags

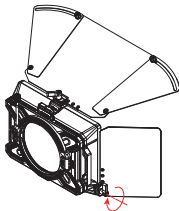

5 Adjustment of the side flags opening and closing angle

