

SmallRig

RM01 Kit
mini LED Video Light

User Manual

Foreword

Thank you for choosing the SmallRig RM01 Kit mini LED Video Light.

Instructions

- Please read this User Manual carefully.
- Please keep this User Manual. Always keep this User Manual when passing the products on to the third party.
- Heed all warnings and follow all instructions in this User Manual.
- Never remove the non-detachable lithium battery without permission.
- When the battery is not in use for a long time, please charge and discharge the battery every 6 months, and provide it with about 60% of the electric quantity to prolong its use life.
- Since there are some hazardous substances in the battery, please do not discard it. Instead, dispose of the product that is damaged or will never be used according to the waste management measures.

Warnings

Please do not disassemble the product or change its battery. If you have any questions, please contact the seller to apply after-sales service.

In the Box

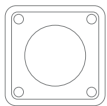

RM01 Video Light × 3

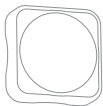

Diffuser × 3

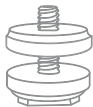

Cold Shoe × 3



Honeycomb × 3



Blaster × 3



Barndoor × 3



Magnetic Frame × 3



Color Filter × 24



Charging Cable × 3



Tripod × 3



User Manual × 1



Carrying Case × 1

Product Display

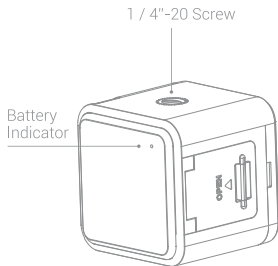
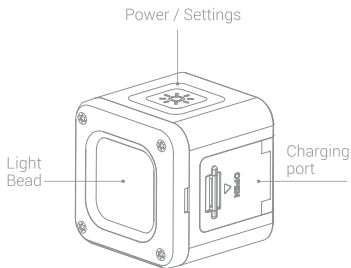

Charging

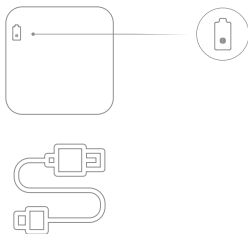

*The battery indicator will turn red when the battery level is too low.

Power / Setting



- a. long press to turn on / off the light
- b. short press to adjust the brightness

Installation

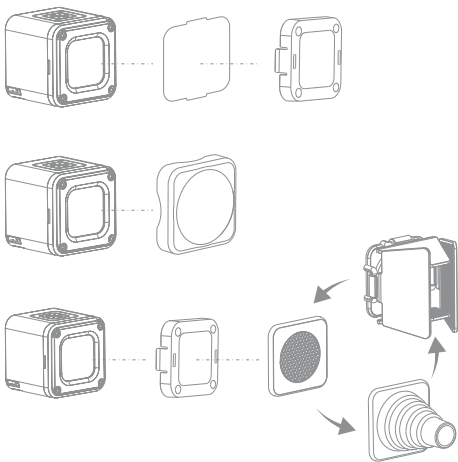

Specifications

Power	3W	CCT	5500K ± 200K
Charging port	USB-C	Beam Angle	60°
Current	≥0.5A	Input Voltage	DC 5V
Brightness Adjustment	4 levels	LED Lifespan	>50,000h
Illumination	1000LUX 0.5m 300LUX 1m	Working Time	53mins / 100% brightness; 5h / 20% brightness
Light Source	COB	TLCI	95
CRI	95+	Dimension	38 × 38 × 36mm
Battery Type	3.7V, 800mAh	Net Weight	135g

SmallRig

RM01 Kit
迷你摄影补光灯套装

用户手册

前言

感谢您购买SmallRig品牌产品。

重要提示

- 使用本产品之前,请仔细阅读用户手册。
- 请妥善保管用户手册,将产品交给他人使用时,请务必携带用户手册。
- 请注意所有警告提示并遵循用户手册内的所有指令。
- 本产品含内置式不可拆卸锂电池,严禁擅自拆机。
- 电池在长时间储存不用时,应在6个月内进行一次充放电维护,并恢复60%左右的带电量,以延长电池的使用寿命。
- 电池内部有少许有害物质,请勿任意丢弃,请将损坏或是不再使用的产品,依照废弃物管理办法回收处理。



请勿拆卸产品或更换电池,如果您怀疑产品有任何问题,请联络购买平台,申请售后处理。

包装清单

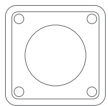

RM01 补光灯 × 3

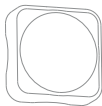

柔光罩 × 3

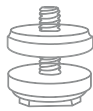

双头冷靴 × 3



蜂窝扩散网 × 3



圆形聚光筒 × 3



四页遮光板 × 3



磁吸框 × 3



色片 × 24



充电线 × 3



三脚架 × 3



用户手册 × 1



收纳包 × 1

产品视图

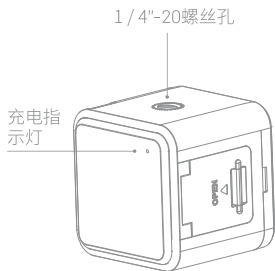
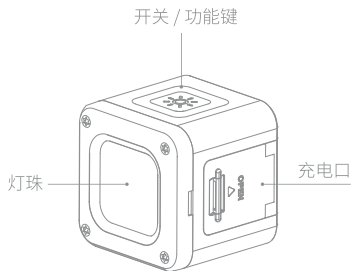

充电

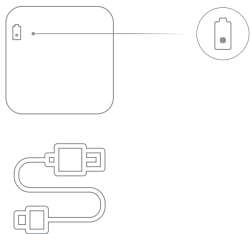

*当指示灯显示红色时请及时
为本产品充电!

开关 / 调节键



- a. 长按功能键可开 / 关机
- b. 短按功能键可进行亮度调节

安装

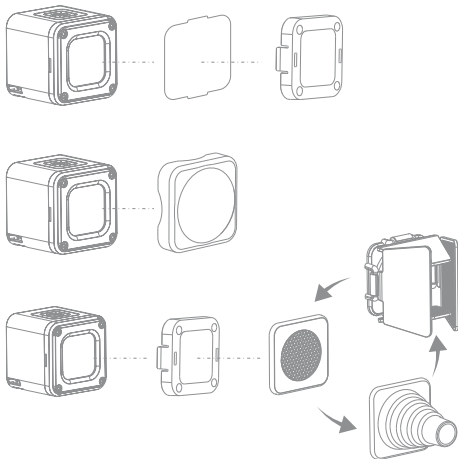

规格参数

功率	3W	色温	5500 ± 200K
充电接口	USB-C	发光角度	60°
充电电流	≥0.5A	充电电压	5V
亮度调节	4级调光	光照度	1000LUX 0.5m 300LUX 1m
光源	COB	灯珠寿命	大于50000h
电池容量	3.7V / 800mAh	产品净重	135g
显色指数	95	TLCI	95+
体积	38 × 38 × 36mm	工作时间	53 mins, 100% 亮度; 5h, 20% 亮度。