

# SmallRig

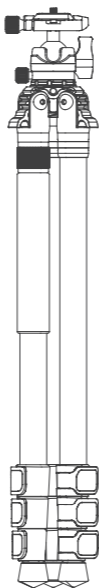

## **Carbon Fiber Tripod AP-10**

User Manual

Thank you for purchasing SmallRig's products.

## Warnings

- Do not exceed the specified load capacity.
- Make sure to lock and keep safe when operating the tripod.
- Do not use a tripod when the temperature is lower than minus 20 degrees or higher than 65 degrees.
- Please clean the tripod when it is getting dirty or wet, do not use it in the sea.
- Do not expose product under direct sunshine or high temperature for a long time.
- Make sure all devices (e.g. cameras) were taken down from the tripod before transportation.
- Keep the tripod and all accessories clean before packing for storage.
- Unless necessary, the equipment does not need to be lubricated regularly. Please use the standard lube only if needed.
- To ensure safety, do not connect the tripod with any power supply.



Please do not disassemble the product ,if you have any question, please contact the seller to apply after-sales service.

## In the Box

1. Carbon Fiber Tripod AP-10 × 1
2. Carrying Bag × 1
3. User Manual × 1

## Tripod Details

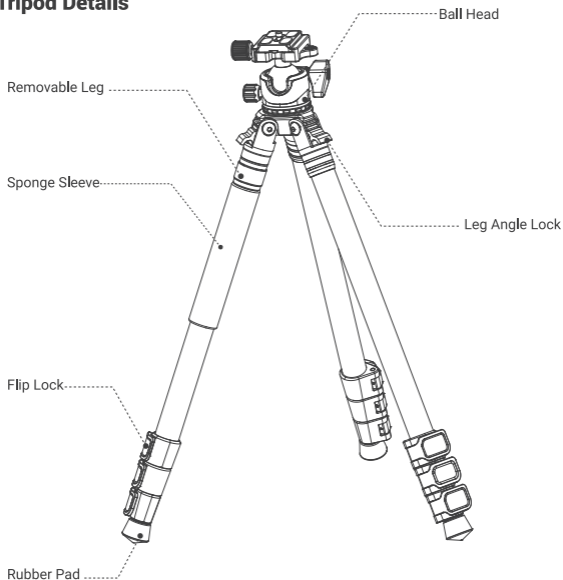

## Ball Head Details

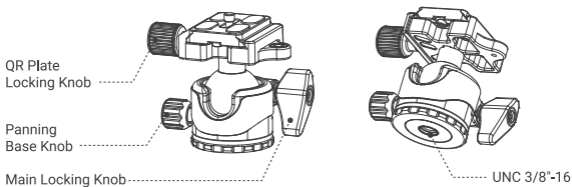

QR Plate Lock & Unlock

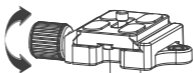

Panning Base Lock & Unlock

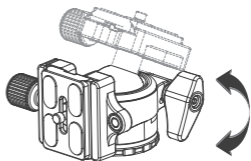
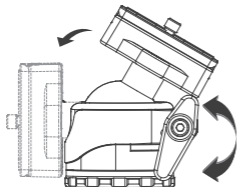
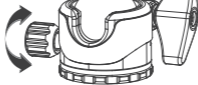

Maining Locking Knob Controls the Ball Activity

## Adjust Leg Angles

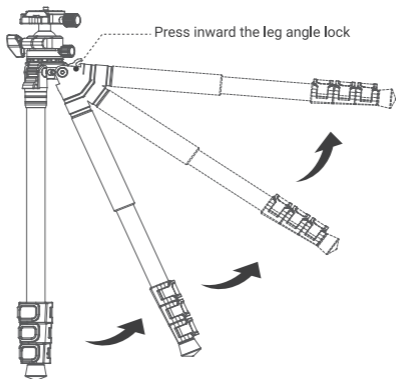

For stable support when shooting on an uneven surface, or for low-angle shots, each leg can be adjusted to 3 preset angles. To set the leg angles:

1. Press outward the leg angle lock
2. Set the leg angle to one of the three preset positions.
3. Press inward the leg angle lock to secure the angle setting.

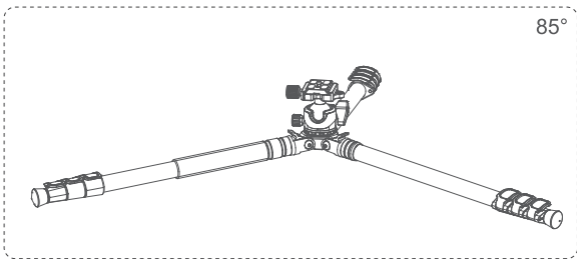
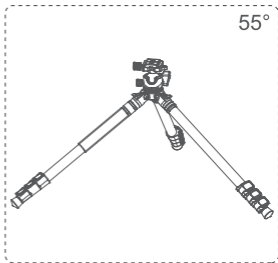
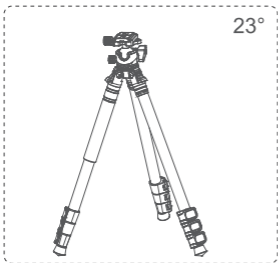

## Tips

- Please remove camera from the tripod before moving the tripod to other locations for shooting to avoid any damage to the camera, as violent shaking may break the camera screw thus break the camera, especially the camera with telephoto lens.
- Extend the tripod legs in the order of from max tube to min tube, while fold the legs in the order of from min tube to max tube.



## Spread Tripod Legs

①



②

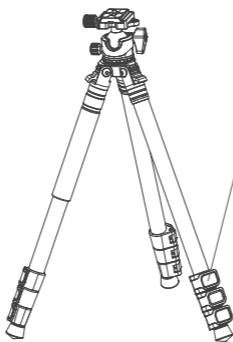

Pull open  
the flip lock

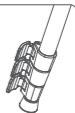

Pull out legs



③

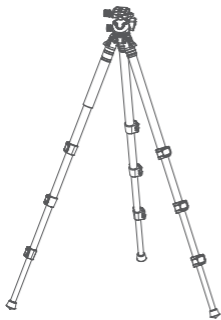

Lock the flip lock to secure legs

## Convert to Monopod

Remove the leg  
with sponge

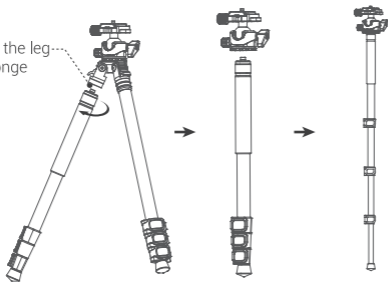

Monopod 3/8"-16 screw  
supports other devices

## Install Tripod Head

UNC 3/8"-16 Screw

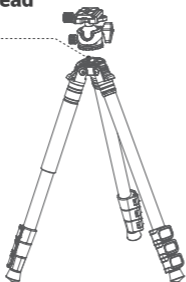

# SmallRig

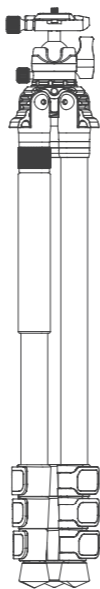

## 轻型碳纤维三脚架 AP-10

用户手册



感谢您购买SmallRig产品。

## 重要提示

- 不要超过最大的制定负重。
- 当使用产品时，时常紧锁其安全装置。
- 切勿在温度低于零下20摄氏度及高于65摄氏度使用，当在潮湿 / 沙地 / 布满尘埃的环境下使用后，谨记将产品弄干及清洁，不建议在海水中使用。
- 切勿将产品长时间放在太阳下暴晒及避免高温环境。
- 建议在运输过程中，将设备（例如相机）从脚架上取下。
- 使用温和清洁剂及柔软毛巾清洁，将尘埃及沙粒从所有锁制及活动部件清除。
- 除非有需要，此设备无需定期添加润滑油。如确实需要时，请使用标准润滑油。
- 为自身安全着想，切勿将产品接触任何电源。



请勿拆卸产品，如果您怀疑产品有任何问题，请联络购买平台，申请售后处理。

## 包装清单

1. 轻型碳纤维三脚架 AP-10 × 1
2. 收纳包 × 1
3. 用户手册 × 1

## 三脚架解析

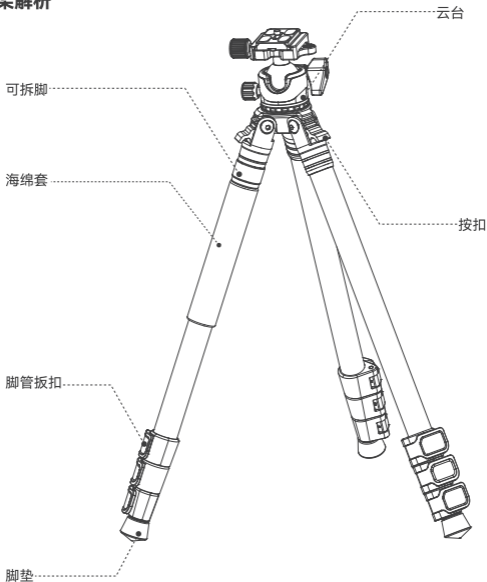

## 云台解析

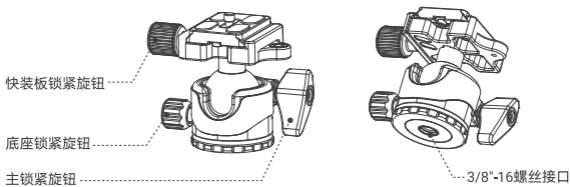

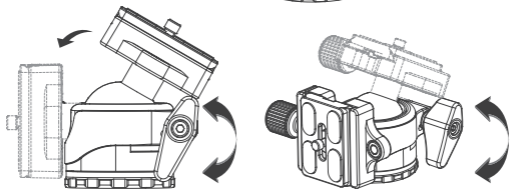
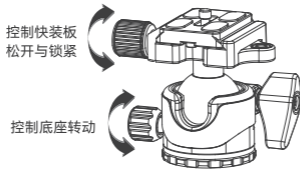

主旋钮用于控制球体的锁紧

## 角度调节

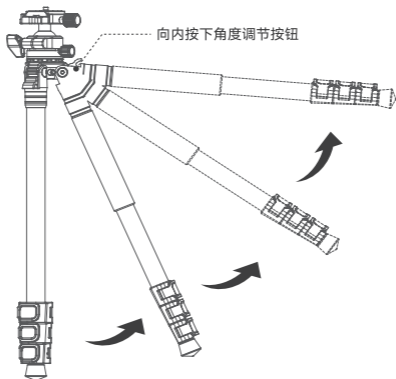

### 三脚架角度调节:

该三脚架的每只支撑脚均可调节三种支撑角度，以适应不同的拍摄要求。如上图所示：向内按压角度调节按钮，同时扳动脚管至相应角度，然后松开角度调节按钮即可锁住角度。

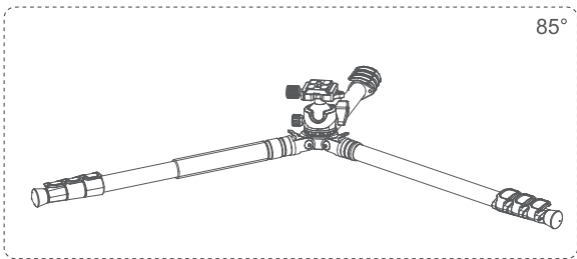
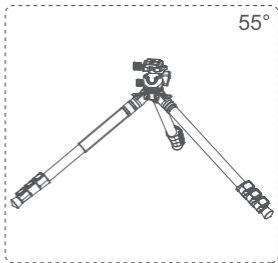
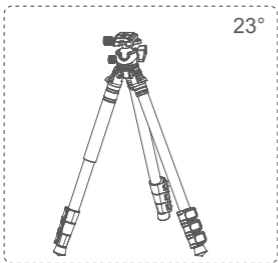

### 温馨提示

- 在使用脚架拍摄且需要移动位置时，请将相机从三脚架上取下，切勿将相机装在脚架上一起移动，剧烈的晃动（特别是安装了长焦镜头的相机）可能会使转接螺丝断裂。进而损坏相机。
- 伸展脚管时，请从最大管径的脚管到最小管径的脚管的顺序伸展。收纳脚管时，请从最小管径的脚管到最大管径的脚管的顺序收纳。



## 伸展脚架

①



②

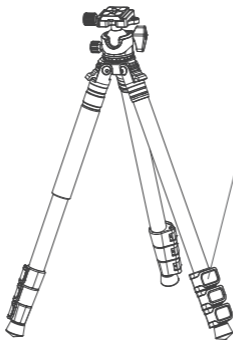

扳开锁紧扣

拉出脚管

③

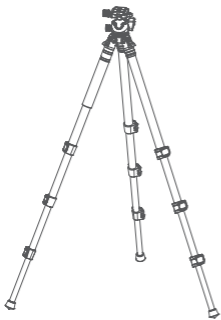

按下锁紧扣,固定脚管。

## 独脚架使用

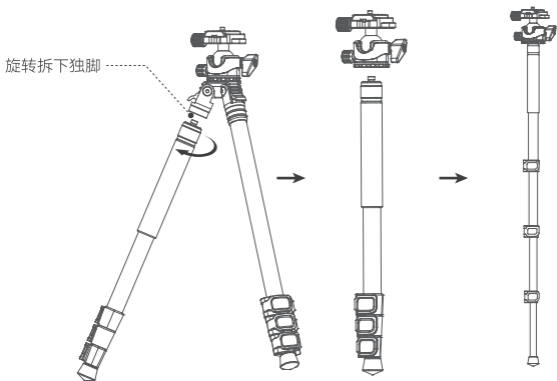

独脚顶端为 3/8"-16 螺丝，可连接其他设备

## 安装云台

