

# SmallRig

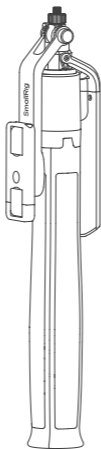

**Encore PT60**

**Windproof Live Broadcast Stabilizer Stand**

**防风手持稳拍直播支架**

Operating Instruction / 操作指引

- Thank you for purchasing SmallRig's product.  
感谢您购买 SmallRig 产品。
- Please read this Operating Instruction carefully.  
使用本产品之前，请仔细阅读操作指引。
- Please follow the safety warnings.  
请注意所有警告提示并遵循使用操作指引的所有指令。

## **In the Box / 包装清单**

Tripod	× 1
三脚架	

Remote Control	× 1
遥控器	

Storage Bag	× 1
收纳袋	

User Manual	× 1
用户手册	

Operating Instruction	× 1
操作指引	

Guarantee Card	× 1
保修卡	

## Product Details / 产品介绍

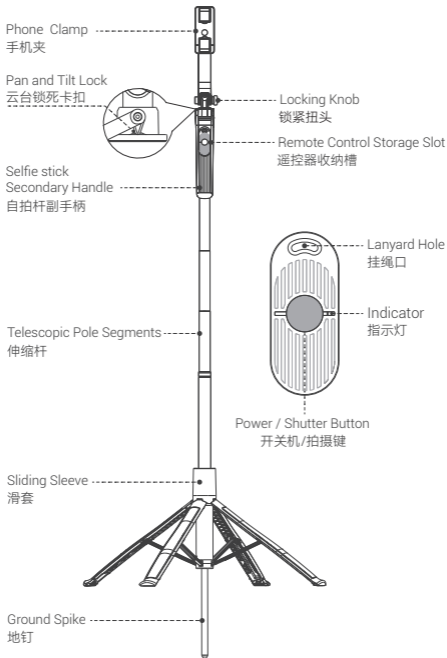

## Usage Instructions / 使用方法

### ① Operating instructions for stand / 支架操作说明

1. Lift the handle upward to unlock it, which allows the phone clamp to rotate 360°. Press downward to lock the handle.

手柄向上抬起解锁手柄，可带动手机夹360°旋转，向下压可锁住手柄。

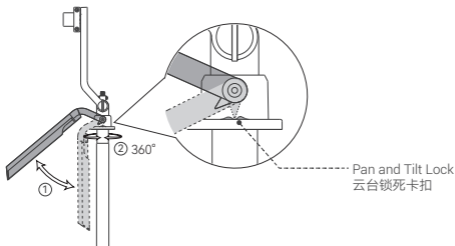

2. Loosen the knob to adjust the angle up and down. Tighten the knob after completing the angle adjustment.

松开扭头可上下调节角度，完成角度调节后锁紧扭头。

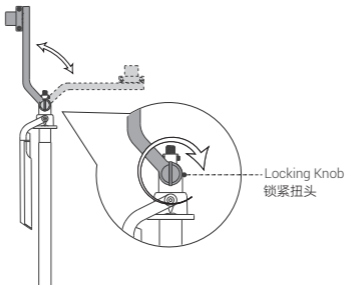

3. Extend the four legs outward.  
将四个脚腿向外掰开。

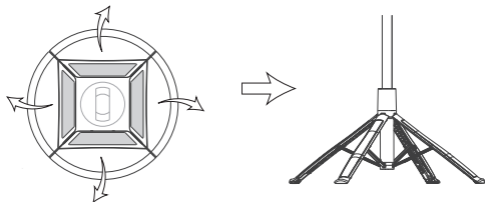

4. Hold the sleeve and pull it down to the bottom to extend the legs to their maximum angle. Then, place it on a flat surface.

按住滑套并将其向下拉至末端完全展开，使脚腿伸展至最大角度，放于水平地面。

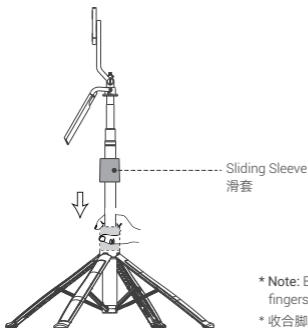

\* **Note:** Be careful of to pinching your fingers when folding the legs.

\* 收合脚腿时请小心夹手。

5. Extend the telescopic pole to the desired height.

拉开伸缩杆至所需高度。

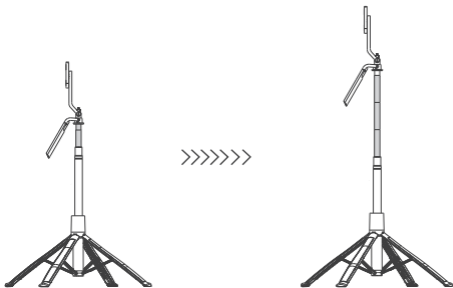

6. Expand the phone clamp, place the phone inside, and clamp it.

拉开手机夹，将手机放入并夹紧。

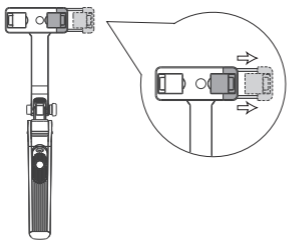

## ② Remote Control Operation Instructions / 遥控器操作说明

- 1. Disassembly:** Use your fingers to grip the top of the remote control and gently pull it outward.  
拆卸：手指抠住遥控器顶部，轻轻向外取出。
- 2. Installation:** Align the remote control with the storage slot and press inward.  
安装：将遥控器与收纳槽位置对应，向内按压。

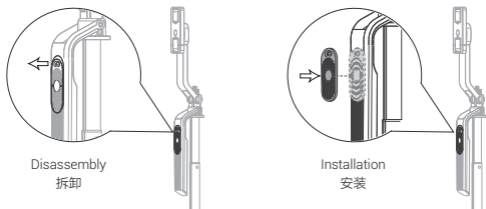

- 3. Shutter button:** Short press for 1 second to take photos and record videos, long press for 3 seconds to power on/off. The indicator light will flash quickly 3 times when powering on/off.  
拍摄键：短按1S可拍照录像，长按3S可开关机，开关机时指示灯快速闪烁3次。



4. **Connection pairing:** A slow flashing of the indicator light after powering on indicates entering pairing mode. Open the Bluetooth settings on your phone and search for the remote control named "SmallRig PT60" to pair. Once successfully connected, the indicator light will stop flashing.

**连接配对:** 开机后指示灯缓慢闪烁则代表进入配对状态, 此时打开手机蓝牙, 搜索遥控器名称" SmallRig PT60 "连接配对, 连接成功后指示灯停止闪烁。

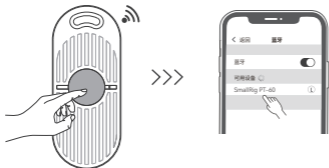

### ③ Remote Control Operation Instructions / 地钉的安装和收纳

1. Extend the legs and rotate the ground spike counterclockwise to remove it.  
打开脚腿, 逆时针旋转地钉头取出地钉。
2. Flip the ground spike over and rotate its head clockwise into the ground spike compartment. After installation, it can be inserted into soft surfaces such as grass or sand, but should not be used on concrete or rocky surfaces.  
将地钉翻转, 地钉头顺时针旋入地钉收纳腔内, 完成安装后可插入草地、沙地等柔软地面, 不可用于水泥或岩石地面。

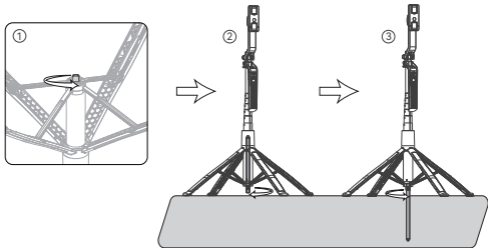



## Specifications / 产品参数

Material(s) 材质	ABS, Aluminum Alloy ABS、铝合金
Work Height 工作高度	13.2 - 72.8in 335.0 ~ 1850.0mm
Payload 支架承重	35.3oz 1.0kg
Storage Height 收纳高度	13.2in 335.0mm
Telescopic Pole Segments 伸缩杆节数	6 6节
Tripod Leg Length 地钉长度	6.7in 170.0mm
Tripod Leg Diameter 地钉直径	φ0.35in φ9.0mm
Remote Control Battery 遥控器电池	CR1632
Working Voltage 工作电压	3.0V
Battery Capacity 电池容量	120mAh
BLE BLE	V5.0
Remote Control Range 遥控距离	32.8ft 10.0m
Phone Clamp Capacity 手机夹适配尺寸	2.6in - 3.8in 65.0mm ~ 97.0mm

Specifications subject to change without prior notice. Please refer to the physical product for the most up-to-date information.

技术参数如有改动，以实物为准，恕不另行通知。



FREE YOUR DREAM

执行标准: GB 4943.1-2022

FCC ID: 2BC2U-PT60

CE FCC RoHS



LQ-B275-18  
Made in China  
中国制造

