

SmallRig

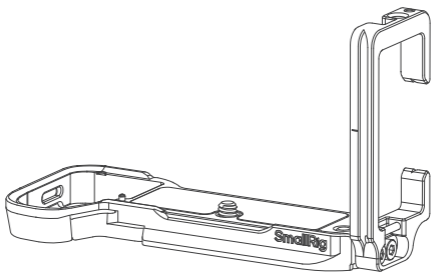

L-Bracket for Sony Alpha 7C II / Alpha 7CR

索尼Alpha 7C II / Alpha 7CR L型安装板

Operating Instruction / 操作指引

- Thank you for purchasing SmallRig's product.
感谢您购买 SmallRig 产品。
- Please read this Operation Guide carefully.
使用本产品之前，请仔细阅读操作指引。
- Please follow the safety warnings.
请注意所有警告提示并遵循使用操作指引的所有指令。

In the Box / 包装清单

L-Bracket	× 1	L型安装板	× 1
Allen Wrench	× 1	六角扳手	× 1
Operating Instruction	× 1	操作指引	× 1
Guarantee Card	× 1	保修卡	× 1

Product Details / 产品介绍

① 1/4"-20 Threaded Hole
1/4"-20螺纹孔

② Arca-Swiss Plate
阿卡快装板

③ Strap Slot
肩 / 腕带孔

④ QD socket
QD 孔

⑤ Flat-Head Screwdriver
一字扳手

⑥ Anti-twist Pin
防偏转销钉

⑦ Hinged Arm
开合扳手

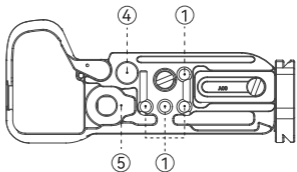
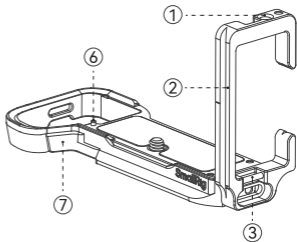

Installation Instruction / 安装步骤

Align the bottom of the camera with the anti-twist pin and 1/4"-20 screw on the L-bracket, then use the flat-head screwdriver to lock the 1/4"-20 screw.

将相机底部对准L型安装板的防偏转销钉和1/4"-20螺丝，然后使用一字扳手锁紧1/4"-20螺丝。

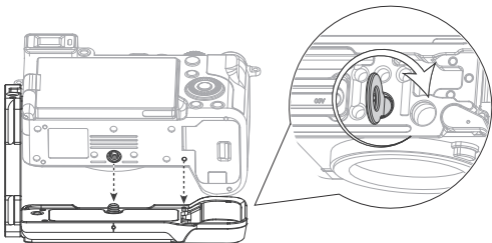

Battery Replacement / 电池更换

The battery can be installed or replaced after opening Hinged Arm.

将开合扳手打开之后即可进行电池的安装或更换。

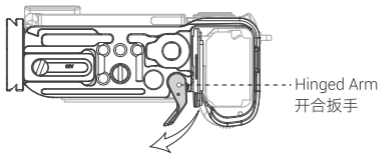

Note:

注意事项:

1. After using this product, please adjust the LCD screen to the lower left state before opening it to the side, the LCD screen can only be rotated about 120° .
1. 使用此产品后，请先将LCD屏调节至左下图状态后再往侧边打开，LCD屏只能旋转约 120° 。

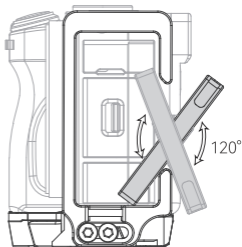
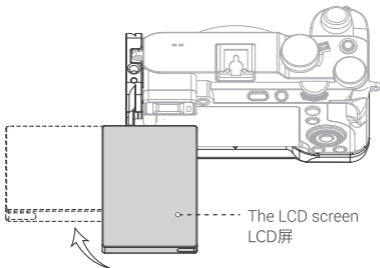

2. When you need to use the camera's left port, use the flat-head screwdriver to loosen the bottom and pull out the side plate.

2. 需要使用相机左侧接口时，请使用一字扳手拧松底部将侧板拉出。

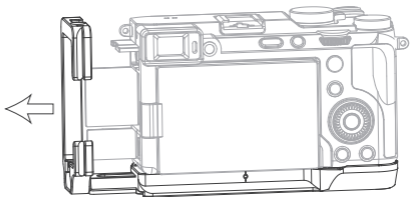
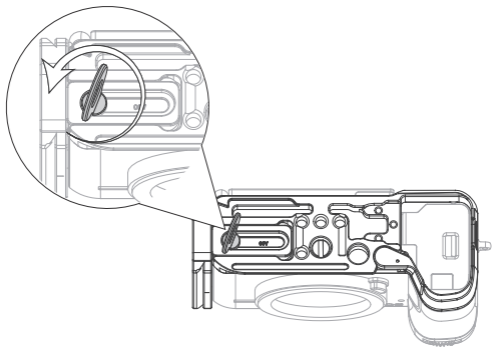

Specifications / 产品参数

Compatibility 兼容性	Sony Alpha 7C II / Alpha 7CR 索尼Alpha 7C II / Alpha 7CR
Product Dimensions 产品尺寸	133.7 × 82.6 × 57.3mm 5.2 × 3.2 × 2.2in
Product Weight 产品重量	100 ± 5g / 3.53 ± 0.17oz
Material (s) 主要材质	Aluminum Alloy, Stainless Steel 铝合金、不锈钢

执行标准: GB/T 26572-2011

www.smallrig.com

CE RoHS



LQ-P1262-18
Made in China
中国制造

