

SmallRig

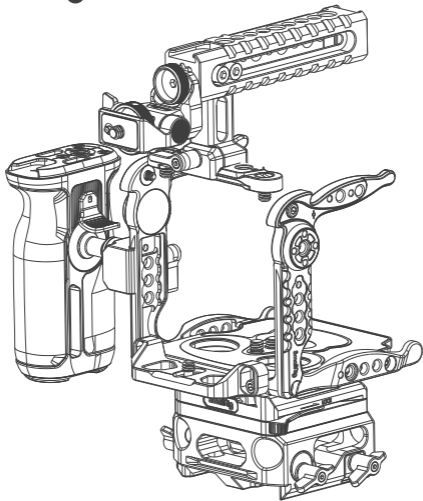

## **Advanced Cage Kit for RED KOMODO**

User manual

Thank you for purchasing SmallRig's product.

## Warnings

- Please read this User Manual carefully.
- Please keep this User Manual. Always keep this User Manual. When passing the products on to the third party.
- Heed all warnings and follow all instructions in this User Manual.

## In the Box



Right Side Plate × 1

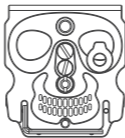

Baseplate × 1



Left Side Plate × 1



Top Plate × 1



Lens Mount  
Adapter Support × 1

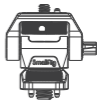

Monitor Mount × 1

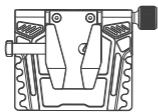

V-Mount Battery Plate × 1

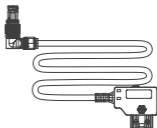

D-TAP to Lemo Power Cable × 1

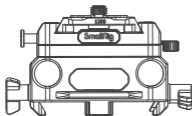

Manfrotto Mount Plate Kit × 1

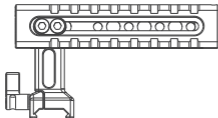

Top Handle × 1

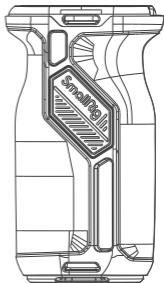

Rotating NATO Handle × 1

## Product Detail Display

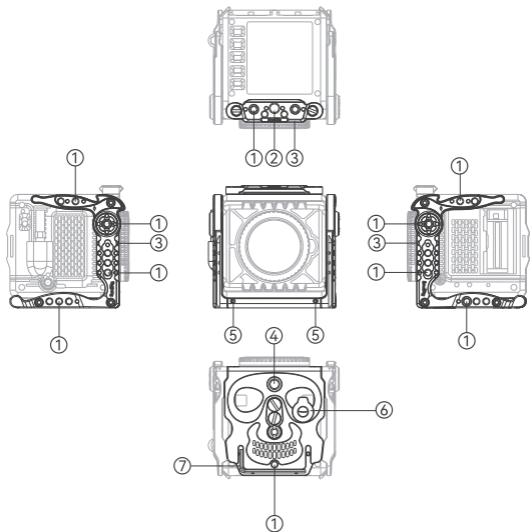

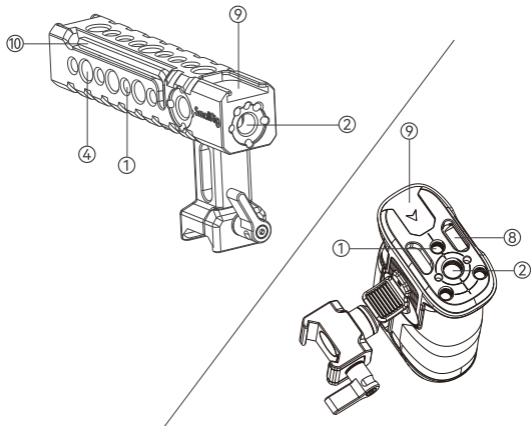

- ① 1/4"-20 Threaded Hole
- ② ARRI 3/8"-16 Locating Hole
- ③ NATO Rail
- ④ 3/8"-16 Threaded Hole
- ⑤ M4 Threaded Hole

- ⑥ Flat-Head Screwdriver
- ⑦ Allen Wrench
- ⑧ Strap Slot
- ⑨ Cold Shoe Mount
- ⑩ Allen Wrench

# 1. Cage Installation Introduction

## ① Baseplate Installation:

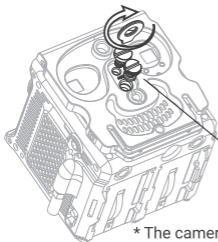

Align the Baseplate with the 1/4"-20 threaded hole and 3/8"-16 threaded hole on the bottom of the camera and lock the 1/4"-20 screw and 3/8"-16 screw with the Flat-Head Screwdriver.

\* The camera is not included in the package

## ② Side Plate Installation (same steps for Left and Right Side Plate):

Align the Side Plate with the M4 threaded holes on the side of camera and Baseplate, use the Allen Wrench ⑦ to lock the one M4 screw on the top and the two M4 screws on the bottom.



\* The camera is not included in the package



### ③ Top Plate Installation:

Align the Top Plate with the 1/4"-20 threaded holes on the top of the camera (with the logo facing forward) and secure the Top Plate by locking the two 1/4"-20 screws with the Flat-Head Screwdriver.

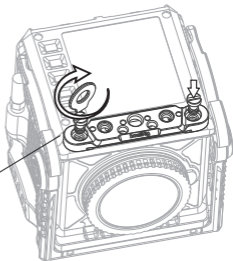

\* The camera is not included in the package

## 2. Manfrotto Mount Plate Kit Installation Introduction

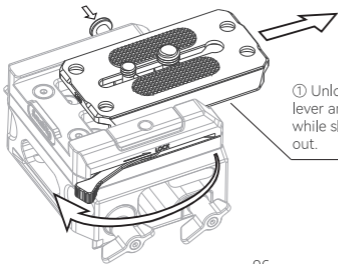

① Unlock the Mount Plate's locking lever and press the anti-off button while sliding the quick release plate out.

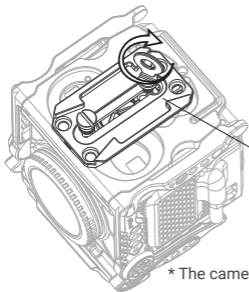

② Align the quick release plate screws with the 1/4"-20 threaded hole and 3/8"-16 threaded hole on the bottom of the Baseplate and lock them in place with the Flat-Head Screwdriver.

\* The camera is not included in the package

Slide the quick release plate and camera into the Mount Plate and pull the lever to lock it in place.

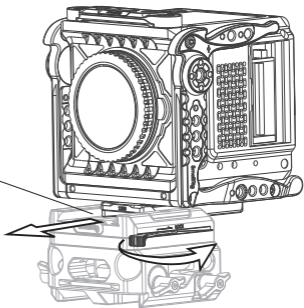

\* The camera is not included in the package



### 3. Top Handle Installation Introduction

Loosen the knob of Top Handle (approx. 2 turns) to unlock the NATO clamp, slide the handle into the Top Plate from left to right and then lock the knob.

※ Make sure the knob is facing the lens when mounting

\* The camera is not included in the package

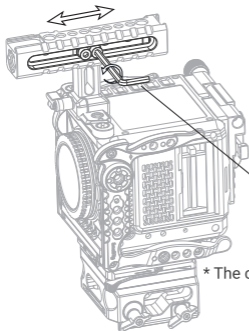
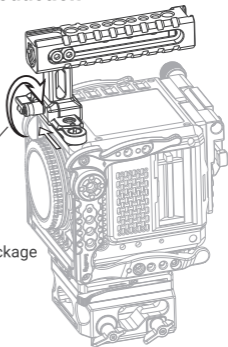

Depending on the application, the front and rear adjustment can be made by loosening the two 1/4"-20 screws on the side of the Top Handle with the Allen Wrench ⑩.

\* The camera is not included in the package

## 4. Monitor Mount Installation Introduction

Monitor Mount Installation:

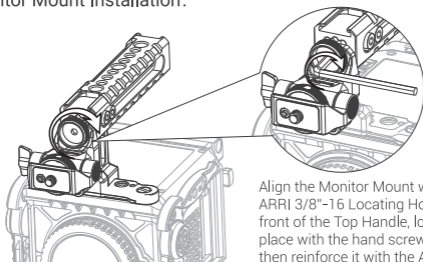

Align the Monitor Mount with the ARRI 3/8"-16 Locating Hole in the front of the Top Handle, lock it in place with the hand screw and then reinforce it with the Allen Wrench ⑩.

\* The camera is not included in the package

## 5. Rotating NATO Handle Installation Introduction

Loosen the knob of the Handle (approx. 2 turns) to unlock the NATO clamp, align the Side Plate's NATO Rail and slide it in from the bottom to the top, locking it in place by means of the knob.

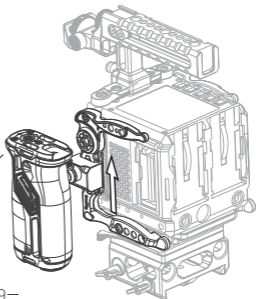

※ Make sure the knob is facing the lens when mounting

\* The camera is not included in the package

## 6. V-Mount Battery Plate Installation Introduction

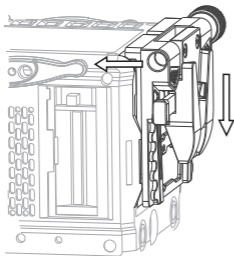

Align the V-Mount Battery Plate with the battery mounting slot at the camera's rear and press the Plate forward while snapping it down until it locks into place.

## 7. D-TAP to Lemo Power Cable Installation Introduction

To install the V-Mount battery, loosen the side knob to open the V-Mount Battery Plate upwards and lock it in place, connect the lemo end of the power cable to the camera [DC-IN] connector and the D-TAP end to the V-Mount battery [D-TAP] connect.

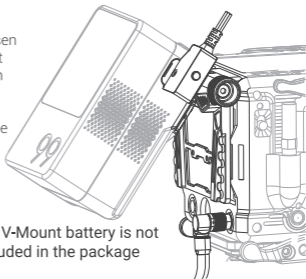

\* The V-Mount battery is not included in the package

## 8. Lens Mount Adapter Support Installation Introduction

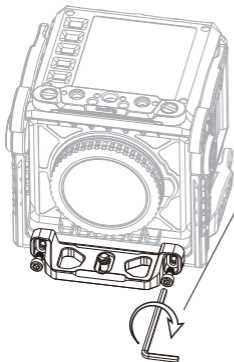

Align the Lens Mount Adapter Support with the M4 threaded holes on the front of the Baseplate and lock the two M4 screws with the Allen Wrench.

※ **The Lens Mount Adapter Support only fits the following Lens Mount Adapter:**  
Metabones ARRI PL Lens to Canon RF-Mount T Cine Speed Booster ULTRA 0.71x (EOS-R)  
Metabones Canon EF Lens to RF-Mount T CINE Speed Booster Ultra 0.71x Adapter (EOS-R)

\* The camera is not included in the package

### Compatibility

RED KOMODO

### Specifications

Product Dimensions: 183.7 × 187 × 231.5mm

Product Weight: 1214g ± 5g

Material(s): Aluminum Alloy, Stainless Steel, Carbon Fiber, POM