

SmallRig

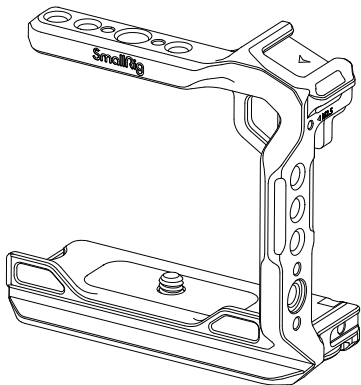

Half Cage for Sony Alpha 6700 / 6600 / 6500 / 6400

- User Manual -

Thank you for purchasing SmallRig's product.

Warnings

- Please read this User Manual carefully.
- Please keep the user manual properly, and be sure to attach this user manual when handing over the product to others.
- Please heed all warnings and follow all instructions in the owner's manual.

In the Box

Half Cage × 1

User Manual × 1

Product Details

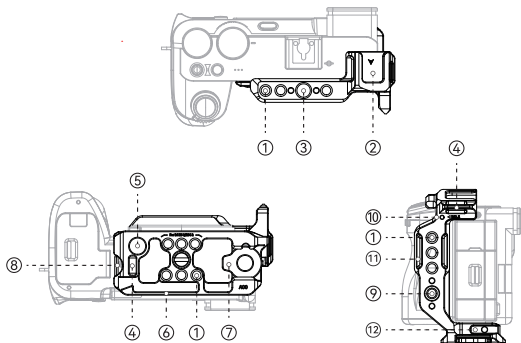

① 1/4"-20 Threaded Hole

② Cold Shoe Mount

③ ARRI 3/8"-16 Locating Hole

④ Wrist / Shoulder Strap Slot

⑤ QD Socket

⑥ Arca-Swiss Quick Release Plate

⑦ Flat-Head Screwdriver

⑧ Allen Wrench

⑨ 1/4"-20 Locating Hole

⑩ M2.5 Threaded Hole

⑪ NATO Rail

⑫ HDMI Cable Clamp Mounting Hole

Installation Instruction

Alpha 6700:

1. Remove the camera lens and the shoulder strap hooks on left side.

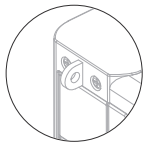

* The package does not include the camera.

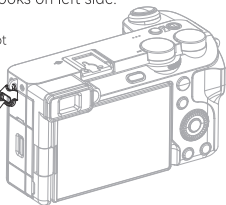
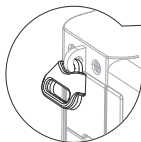

2. Remove the small plate and M2.5 screw on the left side of the cage using the Allen Wrench.

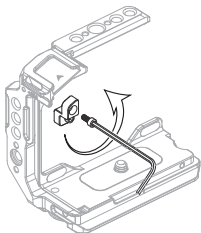

3. Put the camera into the cage from back to front

* The package does not include the camera.

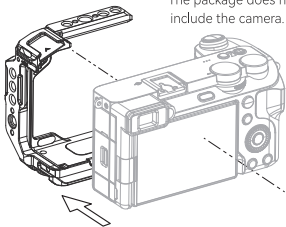

4. Use the Flat-Head Screwdriver to lock the bottom 1/4"-20 screw.

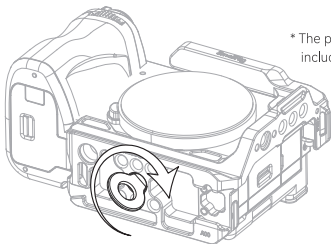

* The package does not include the camera.

5. Use the Allen Wrench to lock the M2.5 screw removed in step 2 through the left shoulder strap hook hole to the cage.

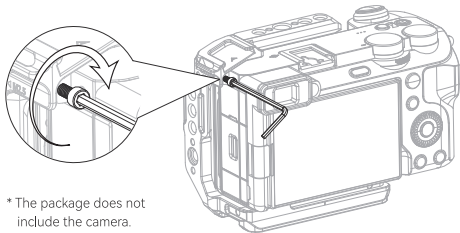

* The package does not include the camera.

Alpha 6600 / Alpha 6500 / Alpha 6400:

1. Remove the camera lens and the shoulder strap hooks on left side.



* The package does not include the camera.

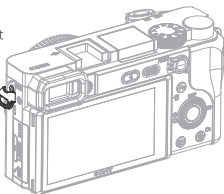
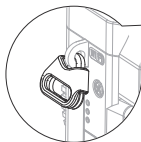

2. Remove the M2.5 screw on the lower left side of the cage using the Allen Wrench.

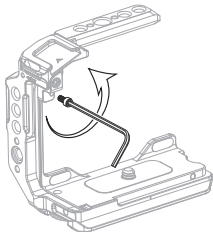

3. Put the camera into the cage from back to front.

* The package does not include the camera.

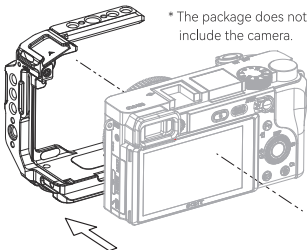

4. Use the Flat-Head Screwdriver to lock the bottom 1/4"-20 screw.

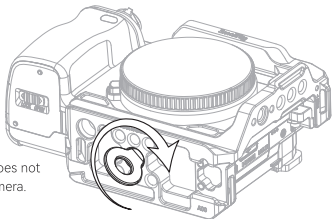

* The package does not include the camera.

5. Use the Allen Wrench to lock the M2.5 screw removed in step 2 through the left shoulder strap hook hole to the cage.

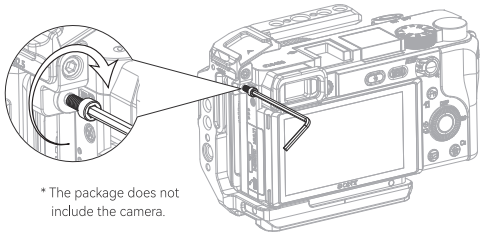

* The package does not include the camera.

Note

When used on the Sony Alpha 6600 / 6500 / 6400, accessories such as the Sony ECM-W2BT microphone and HVL-F32M flash are not compatible.