

SmallRig

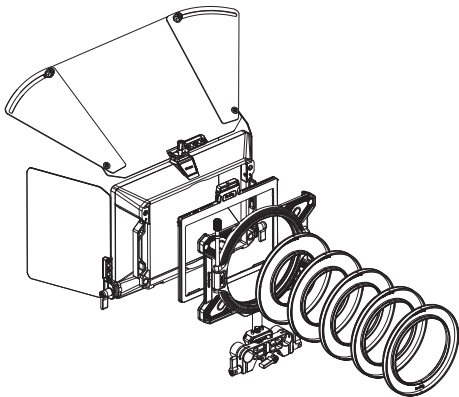

Star-Trail / Revo-Arcane Matte Box Systems
Instructions and Accessories Introduction

In order to ensure user's safety and prevent the product damages caused by any improper use, please carefully read the "Warnings" below and properly keep this User Manual for future reference.

Foreword

Thank you for purchasing SmallRig's product.

Warnings

- Please read this User Manual carefully.
- Please keep the user manual properly, and be sure to attach this user manual when handing over the product to others.
- Please heed all warnings and follow all instructions in the owner's manual.
- Incompatible with 2mm thick 100 x 100mm and 100 x 150mm slide-in filters.
- Cannot hold the slide-in filter and circular filter at the same time.
- Incompatible with circular filters having an outside diameter larger than 100mm.
- Please put Filter Frame (4 x 4") 3648 in the innermost slot near the lens.
- Please put the VND Filter Kit 3651 in the innermost slot near the lens after removing the lens hood.



Only compatible with 4mm slide-in filters.

Intended Use

- Please read this User Manual carefully, especially the "Warnings".
- Please use or store the product in the environment mentioned herein.
- It will be regarded as improper use when the users are not correctly following the user manual or using the product under the specific working condition.

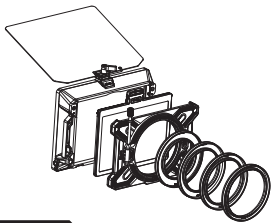

ID: 3556

Multifunctional Modular Matte Box (Φ95mm)
Basic Kit

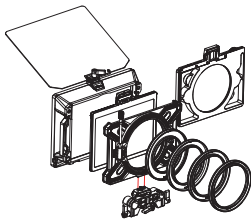

ID: 3645

Multifunctional Modular Matte Box (Φ95mm)
VND Kit

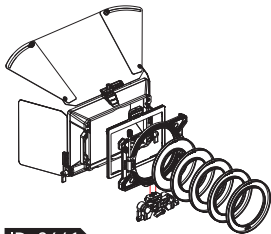

ID: 3641

Multifunctional Modular Matte Box (Φ114mm)
Basic Kit

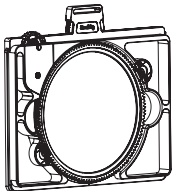

ID: 3651

VND Filter Kit

Optional Kits for Star-Trail Series



ID: 3647

Side Flag Kit
($\Phi 95\text{mm}$)



ID: 3383

Adapter Rings Kit
for mini Matte Box



ID: 3654

Clamp-On Ring Kit
($\Phi 80 / 85 \sim 95\text{mm}$)

Optional Kits for the Revo-Arcane Series



ID: 3408

Clamp-On Ring Kit
for Matte Box 2660



ID: 3409

Silicone Donut with 114mm Rear Opening
for Matte Box 2660

Optional Kits for Star-Trail and Revo-Arcane Series

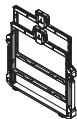

ID: 3649

Filter Frame Kit (4 x 5.65")



ID: 3648

Filter Frame (4 x 4")

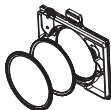

ID: 3651

VND Filter Kit



ID: 3652

15mm LWS Support

Installation of the Matte Box

- 1 Select the appropriate threaded adapter ring based on the lens being used.



Note: A lens with a 95mm outer diameter can be mounted directly without an adapter ring.

- 2 Align the matte box with the lens centerline.

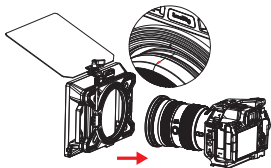

- 3 Secure the Matte Box by twisting the screw

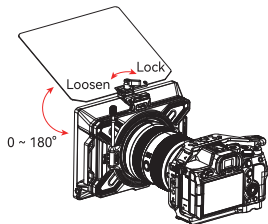
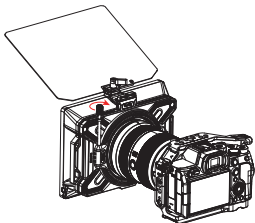

Mounting filters into the 4 × 5.65" and 4 × 4" Filter Frames

- 1 Press the filter frame safety lock to remove the filter frame

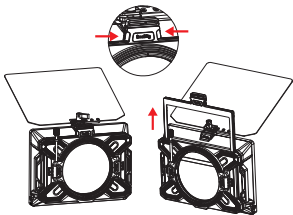

- 2 The filter is inserted diagonally into the filter frame

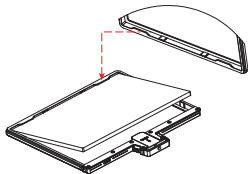

- 3 Pull up the automatic lock to allow the filter to lay flat and release the lock to complete the installation

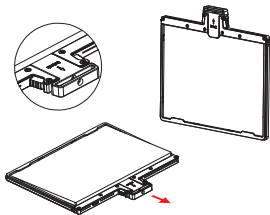

- 4 Align the frame in the guide slot and push down until you hear a "click". Installation is complete!

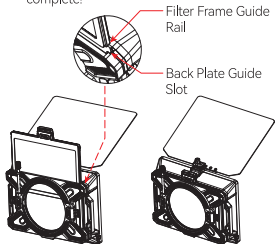

Removal and Installation of the Matte Cover

- 1** Pull up the locks on both sides of the matte cover at the same time

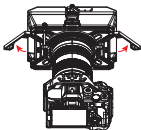

- 2** Unlock by pulling the top section in the direction shown

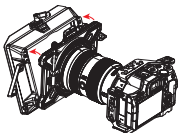

- 3** Completely remove the matte cover by pulling up as indicated

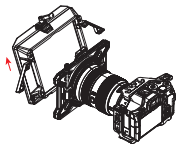

- 4** Align the connection points

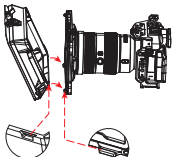

Matte Box
slot

Back Plate
inverted tab

- 5** Push the matte cover towards the Back Plate

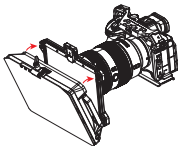

- 6** When you hear a "Click," installation is completed

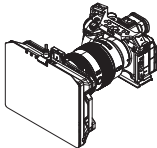

Adding Additional Filters

4 × 5.65" Filter Frame Kit
ID: 3649

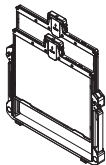

- 1** Align the connection points

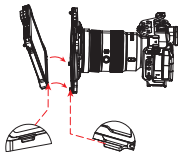

U-shaped
filter frame
slot

Backplate
inverted tab

- 2** Push the filter frame kit
towards the Back Plate

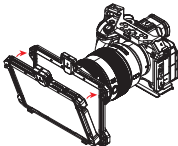

- 3** When you hear a "Click," installation is
completed

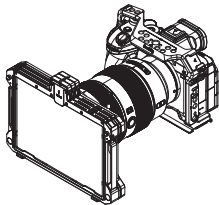

- 4** Complete the installation of the matte cover

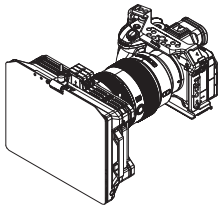

Removal and Installation of the VND Filter

VND Filter Kit

ID: 3651

Consists of two CPL filters

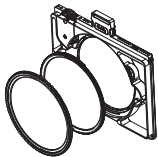

- 1** Align the white wire and separately magnetically aligned for installation

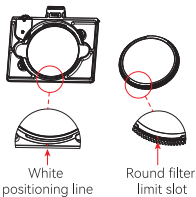

- 2** Locking double-sided anti-release stoppers

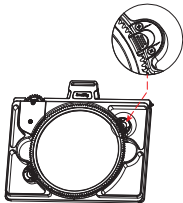

- 3** Align the frame in the guide slot and push down until you hear a "click". Installation is complete!

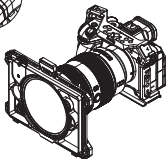
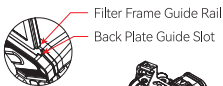

- 4** Manual adjustment of the VND Stops

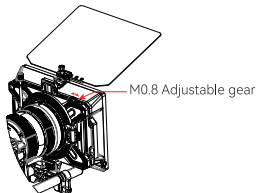

Caution:

- 1: To install the VND filter kit remove the matte cover
- 2: Close to the lens for installation

Installation steps for 15mm LWS Support

15mm LWS Support

ID: 3652

Loosen the knob to ensure free adjustment
up and down

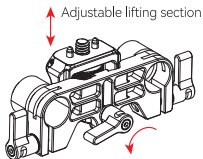

- 1 Align the screw threads of matte box,
Locking and fastening

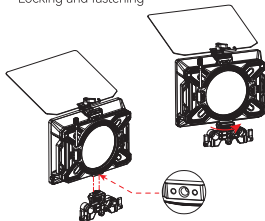

- 2 Align and push in the standard 15mm rod
and adjust the position

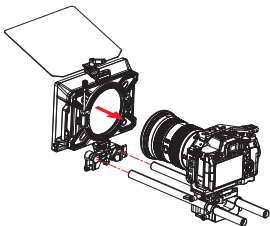

- 3 Adjusting the height of the lens
Adjusting knobs, Locking and fastening

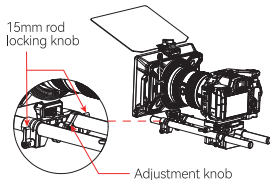

Note: Compatible with standard 15mm rod
system, height Adjustable to 20.4mm

Replacement of the top flag and installation of the side flags

Side Flag Kit (95mm)

ID: 3647

Only suitable for Star-Trail series matte boxes



1 Removal of top flag

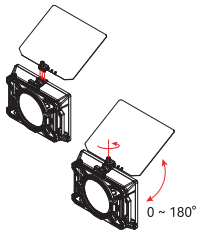

2 installation of top flag

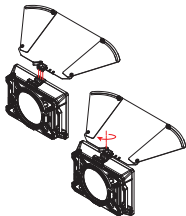

3 Adjust the top flag sector angle

adjustable nuts for
Scalloped flag

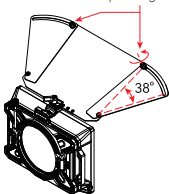

4 installation of side flags

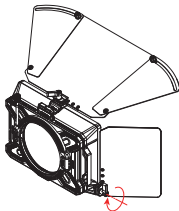

5 Adjustment of the side flags opening and closing angle

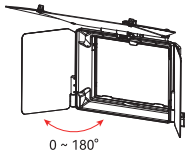

Service Warranty

Please keep your original receipt and guarantee card. Be sure the dealer has written on it the date of purchase and SN of the product. These are required for warranty service.

After-sale warranty terms:

1. 7 Days DOA Return Policy: Within 7 days from the date of the package receipt, return or replacement can be done if the item received is malfunctioning or physical damaged (not caused by human abused), returnshipping cost will be on SmallRig's charge.
2. SmallRig products are entitled to warranty services as of the date of payment.
 - Electronic products: 1-year warranty, 1-year free warranty service.
 - Non-electronic products: 2-year warranty, 2-year free warranty service.

Note: In case of any conflict between our warranty period policy and applicable laws and regulations of the country/region where the products are sold, the latter shall prevail.

This warranty does not cover:

1. Defect caused by users' violation of the "Warnings" and "Intended Use".
2. The product identification or SN label is removed or defaced in any way.
3. Product damage caused by problems not attributable to the quality of the products such as improper use of the products.
4. Product damage caused by unauthorized modification, disassembly, repair and other acts.
5. Product damage caused by fires, floods, lightning and other force majeure factors.

Warranty Mode:

- For the products within the scope of warranty, SmallRig will repair or replace them on the basis of specific failures; the repaired/replaced products/parts are entitled to the remaining part of the original warranty period.

Contact Information:

- You're advised to contact the online customer service personnel of corresponding shopping platform and submit a repair service application.
- You may also apply for repair service through SmallRig's service email.

Service Email: support@smallrig.com

For more support information: www.smallrig.com/support

Guarantee Card

ID No.	
Item Name	
Purchase Date	
User Name	
Mobile	
Address	
Receipt	

EC	REP
----	-----

Prolinx GmbH
Brehmstr.56,40239 Duesseldorf Germany
eu@eulinx.eu

UK	REP
----	-----

Prolinx Global LTD
27 Old Gloucester Street London, WC1N3AX, UK
eu@eulinx.eu

Manufacturer: Shenzhen Leqi Network Technology Co., Ltd.

Add: Rooms 103, 501 and 601, Building 5, Fenghe Industrial Park, Nos. 1301-50 Guangguang Road,
Longhua District, Shenzhen, Guangdong, China.

Consignor: Shenzhen LC Co., Ltd

Add: Rooms 602, Building 5, Fenghe Industrial Park, No. 1301-50 Guangguang Road, Xinlan Community,
Guanlan Street, Longhua District, Shenzhen, Guangdong, China.

CE **RoHS**



www.smallrig.com

Made in China